



3 Volt, General Purpose Low Noise High f_T Silicon Transistor

MP4T6325 Series

Features

- Low Voltage Operation (3 - 5V)
- High f_T (11 GHz)
- Low Noise Figure with 1-5 mA Current
- Inexpensive
- Available on Tape and Reel

Description

The MP4T6325 series of low voltage silicon bipolar transistors provide low noise figure at a bias of 3-5 volts and collector current of 1 to 5 mA. These inexpensive surface mount transistors are useful for low noise amplifiers and VCOs in portable battery operated RF systems from VHF through 2.5 GHz.

The MP4T6325 series has high f_T (11 GHz) and provides 1.5 dB noise figure with 1-5 mA current and 3 volts bias at 1 GHz. These transistors also have low phase noise when used in 3-5 volt low power battery operated VCOs through 2.5 GHz.

The MP4T6325 series are inexpensive transistors useful for portable battery operated RF systems that require low current drain from 3-5 volts DC supplies.

The MP4T6325 family of transistors is available in chip (MP4T632500), SOT-23 (MP4T632533), SOT-143 (MP4T632539) and in Micro-X (MP4T632535) packages. Surface mount packages are available on tape and reel.

SOT-23

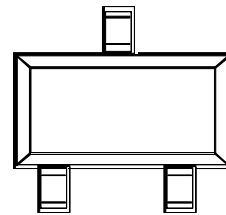

SOT-143

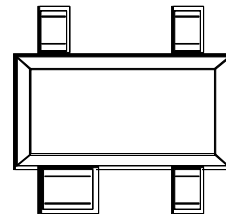

Chip

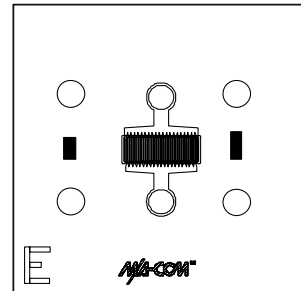

Specification Subject to Change Without Notice

M-Pulse Microwave

1

576 Charcot Avenue, San Jose, California 95131

Tel (408) 432-1480

Fax (408) 432-3440

Electrical Specifications at 25°C

Symbol	Parameters	Test Conditions	Units	MP4T632500 Chip	MP4T632533 SOT-23	MP4T632535 Micro-X	MP4T632539 SOT-143
f_T	Gain Bandwidth Product	$V_{CE} = 3V$ $I_C = 10\text{ mA}$	GHz	11 typ.	10 typ.	11 typ.	11 typ.
$ S_{21E} ^2$	Insertion Power Gain	$V_{CE} = 3V$ $I_C = 10\text{ mA}$ $f = 1\text{ GHz}$ $f = 2\text{ GHz}$	dB	12 typ. 8 typ.	11 typ. 7 typ.	12 typ. 8 typ.	11 typ. 7 typ.
NF	Noise Figure	$V_{CE} = 3V$ $I_C = 2\text{ mA}$ $f = 1\text{ GHz}$	dB	1.5 typ.	1.6 typ.	1.5 typ.	1.6 typ.
GTU (max)	Unilateral Gain	$V_{CE} = 3V$ $I_C = 10\text{ mA}$ $f = 1\text{ GHz}$ $f = 2\text{ GHz}$	dB	14.5 typ. 9 typ.	13 typ. 8 typ.	14.5 typ. 9 typ.	13 typ. 8 typ.
MAG	Maximum Available Gain	$V_{CE} = 3V$ $I_C = 10\text{ mA}$ $f = 2\text{ GHz}$	dB	10 typ.	9 typ.	10 typ.	9 typ.
P_{1dB}	Power Out at 1dB Compression	$V_{CE} = 3V$ $I_C = 15\text{ mA}$ $f = 900\text{MHz}$	dBm	8 typ.	8 typ.	8 typ.	8 typ.
$R_{TH (J-A)}$	Thermal Resistance	Junction/ Ambient	°C/W	—	650 typ.	500 typ.	625 typ.
$R_{TH (J-C)}$	Thermal Resistance	Junction/ Case	°C/W	70 max. ¹	200 typ.	200 typ.	200 typ.

1. Junction/Heat Sink $R_{TH (J-C)}$

Maximum Ratings at 25°C

Parameter	Symbol	Maximum Rating
Collector Base Voltage	V_{CBO}	8 V
Collector-Emitter Voltage	V_{CEO}	6 V
Emitter-Base Voltage	V_{EBO}	1.5 V
Collector Current	I_C	25 mA
Junction Temperature	T_j	200°C
Storage Temperature Chips or Ceramic Packages Plastic Packages	T_{STG}	-65°C to +200°C -65°C to +125°C
Power Dissipation	P_D	150mW ¹

1. See Typical Performance Curves for power derating.

Electrical Specifications at 25°C

Parameters	Conditions	Symbol	Min.	Typ.	Max.	Units
Collector Cut-off Current	$V_{CB} = 5\text{ V}$ $I_E = 0$	I_{CBO}	—	—	100	nA
Emitter Cut-off Current	$V_{EB} = 1\text{ V}$ $I_C = 0$	I_{EBO}	—	—	1	μA
Forward Current Gain	$V_{CE} = 3\text{ V}$ $I_C = 3\text{ mA}$	h_{FE}	20	90	200	—
Collector Base Junction Capacitance	$V_{CB} = 3\text{ V}$ $I_E = 0$ $f = 1\text{ MHz}$	C_{OB}	—	0.52	0.70	pF

Specification Subject to Change Without Notice

M-Pulse Microwave

2

576 Charcot Avenue, San Jose, California 95131

Tel (408) 432-1480

Fax (408) 432-3440

MP4T632535

Typical Scattering Parameters in the Micro-X Package

 $V_{CE} = 3$ Volts, $I_C = 5$ mA

Frequency (MHz)	S _{11E}		S _{21E}		S _{12E}		S _{22E}	
	Mag.	Angle	Mag.	Angle	Mag.	Angle	Mag.	Angle
500	0.486	-80.5	7.164	119.8	0.077	56.6	0.628	-45.8
1000	0.338	-128.0	4.508	93.4	0.112	51.9	0.424	-58.8
1500	0.294	-156.3	3.219	78.1	0.144	50.2	0.345	-65.9
2000	0.284	169.8	2.533	66.1	0.179	47.8	0.305	-74.9
2500	0.283	160.9	2.123	55.5	0.210	44.7	0.280	-83.1
3000	0.281	144.6	1.835	46.3	0.240	41.8	0.266	-90.8
3500	0.290	132.5	1.678	36.8	0.272	36.7	0.256	-103.7
4000	0.320	119.4	1.546	28.3	0.301	33.2	0.254	-113.8
4500	0.333	106.6	1.434	18.9	0.323	29.0	0.245	-125.4
5000	0.358	94.9	1.354	11.5	0.349	25.1	0.241	-135.9
5500	0.382	82.7	1.290	4.0	0.375	21.4	0.246	-146.1
6000	0.405	72.7	1.238	-4.0	0.397	17.7	0.255	-158.0

 $V_{CE} = 3$ Volts, $I_C = 10$ mA

Frequency (MHz)	S _{11E}		S _{21E}		S _{12E}		S _{22E}	
	Mag.	Angle	Mag.	Angle	Mag.	Angle	Mag.	Angle
500	0.326	-116.9	8.628	108.6	0.060	60.9	0.505	-48.5
1000	0.288	-158.6	4.808	86.7	0.098	60.0	0.351	-56.2
1500	0.288	174.6	3.337	73.4	0.135	57.7	0.302	-61.8
2000	0.305	160.8	2.608	62.3	0.170	53.7	0.275	-71.7
2500	0.319	145.8	2.172	52.2	0.204	49.7	0.256	-80.2
3000	0.330	131.0	1.863	43.2	0.234	45.8	0.245	-88.1
3500	0.335	121.4	1.696	34.5	0.268	41.0	0.245	-101.8
4000	0.372	110.2	1.559	25.9	0.299	36.8	0.245	-112.9
4500	0.385	99.4	1.444	16.9	0.322	32.7	0.240	-125.3
5000	0.417	88.6	1.361	9.4	0.350	28.3	0.237	-136.8
5500	0.445	77.1	1.294	3.2	0.379	24.1	0.242	-148.0
6000	0.468	67.4	1.236	-6.0	0.401	20.3	0.253	-160.2

 $V_{CE} = 3$ Volts, $I_C = 15$ mA

Frequency (MHz)	S _{11E}		S _{21E}		S _{12E}		S _{22E}	
	Mag.	Angle	Mag.	Angle	Mag.	Angle	Mag.	Angle
500	0.286	-136.7	9.912	104.1	0.053	65.0	0.428	-50.5
1000	0.278	-173.6	5.355	84.5	0.092	64.6	0.295	-55.5
1500	0.287	168.5	3.679	72.6	0.132	60.8	0.263	-60.3
2000	0.317	149.8	2.875	61.7	0.165	56.6	0.236	-70.3
2500	0.334	135.8	2.377	52.0	0.200	52.2	0.222	-77.5
3000	0.354	121.6	2.029	43.0	0.230	47.7	0.215	-84.3
3500	0.355	112.4	1.834	34.6	0.265	42.7	0.218	-97.2
4000	0.382	100.2	1.653	26.7	0.290	38.9	0.220	-103.8
4500	0.408	92.3	1.552	17.3	0.317	34.1	0.218	-117.6
5000	0.440	82.1	1.456	10.0	0.344	29.7	0.213	-127.1
5500	0.471	71.3	1.377	2.2	0.372	25.2	0.212	-137.0
6000	0.492	62.2	1.312	-5.5	0.392	21.3	0.218	-147.9

Specification Subject to Change Without Notice

M-Pulse Microwave

3

576 Charcot Avenue, San Jose, California 95131

Tel (408) 432-1480

Fax (408) 432-3440

Typical Performance Curves (MP4T632535)

POWER DERATING CURVES

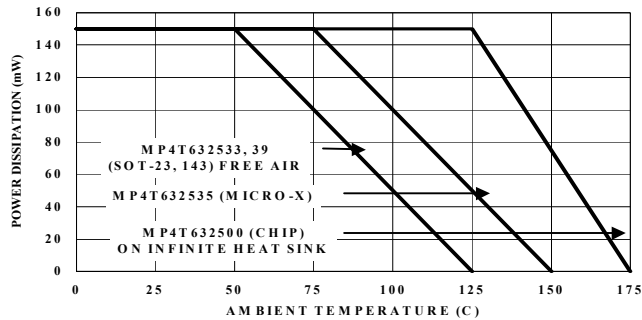

NOISE FIGURE and ASSOCIATED GAIN at VCE = 3 V, 1 GHz vs COLLECTOR CURRENT

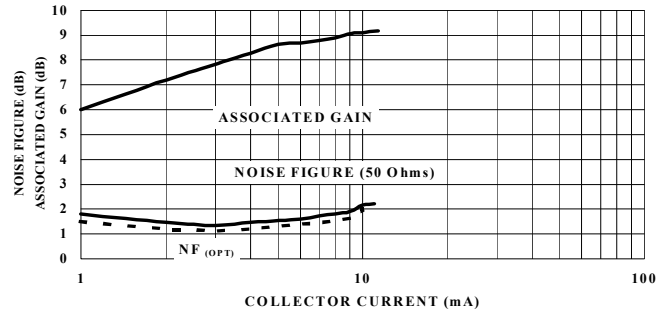

GAIN vs FREQUENCY at VCE=3 V and IC = 10 mA

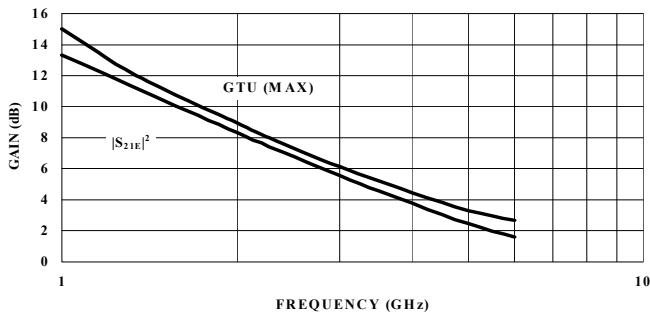

COLLECTOR-BASE CAPACITANCE (C_{OB}) vs COLLECTOR-BASE VOLTAGE

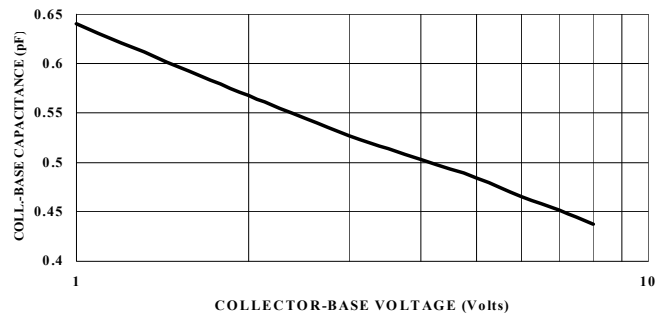

GAIN BANDWIDTH PRODUCT (f_T) vs COLLECTOR CURRENT at VCE=3 V

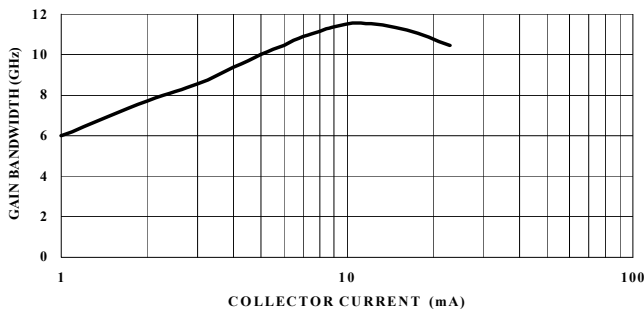

GAIN vs COLLECTOR CURRENT at 2 GHz, VCE=3 V

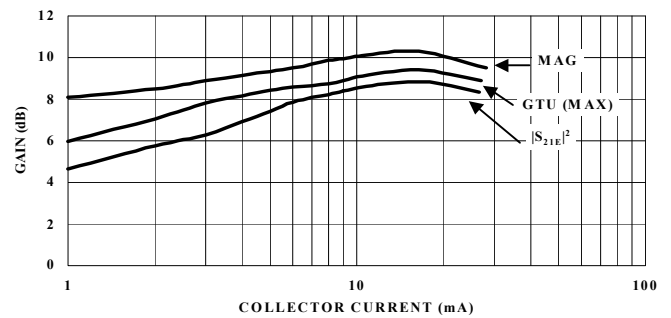

Specification Subject to Change Without Notice

M-Pulse Microwave

4
576 Charcot Avenue, San Jose, California 95131

Tel (408) 432-1480

Fax (408) 432-3440

**Typical Performance Curves
(MP4T632535) Cont.**

DC CURRENT GAIN (h_{FE}) vs COLLECTOR CURRENT at VCE = 3 V

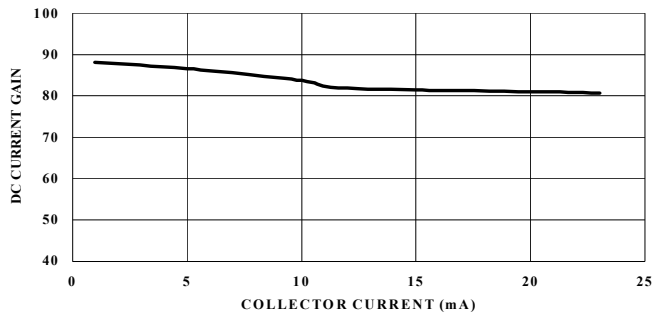

OUTPUT POWER at 1 dB COMPRESSION POINT vs COLLECTOR CURRENT VCE=3V

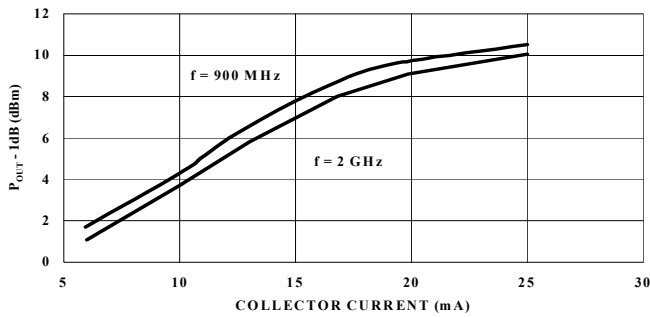

Specification Subject to Change Without Notice

Case Styles

Chip - MP4T632500

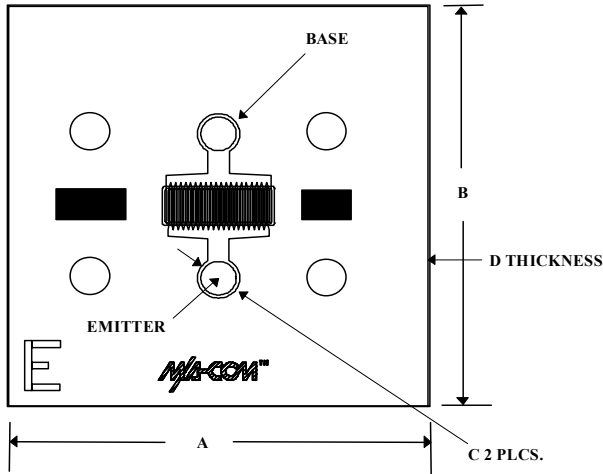

MP4T632500

DIM.	INCHES (Nominal)	MM (Nominal)
A	0.013	0.35
B	0.013	0.35
C	0.0016	0.040
D	0.0045	0.11

SOT-23 - MP4T632533

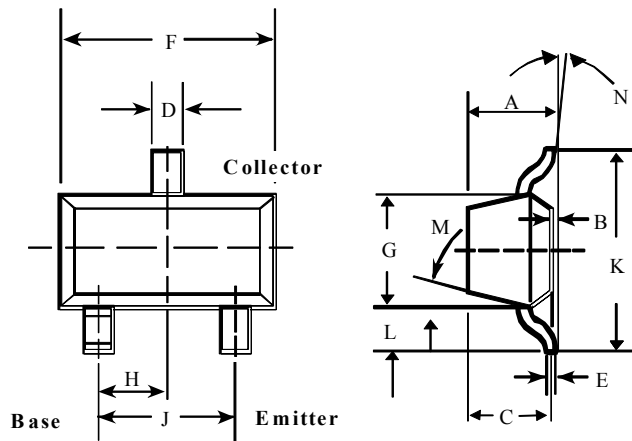

MP4T632533

DIM.	INCHES		MILLIMETERS	
	MIN.	MAX.	MIN.	MAX.
A	—	0.048	—	1.22
B	—	0.008	—	0.20
C	—	0.040	—	1.00
D	0.013	0.020	0.35	0.50
E	0.003	0.006	0.08	0.15
F	0.110	0.119	2.80	3.00
G	0.047	0.056	1.20	1.40
H	0.037 typical		0.95 typical	
J	0.075 typical		1.90 typical	
K	—	0.103	—	2.60
L	—	0.024	—	0.60

DIM.	GRADIENT
M	10° max. ¹
N	2° ... 30°

NOTE:
1. Applicable on all sides

Specification Subject to Change Without Notice

M-Pulse Microwave

6
576 Charcot Avenue, San Jose, California 95131

Tel (408) 432-1480

Fax (408) 432-3440

Case Styles (Con't)

Micro-X - MP4T632535

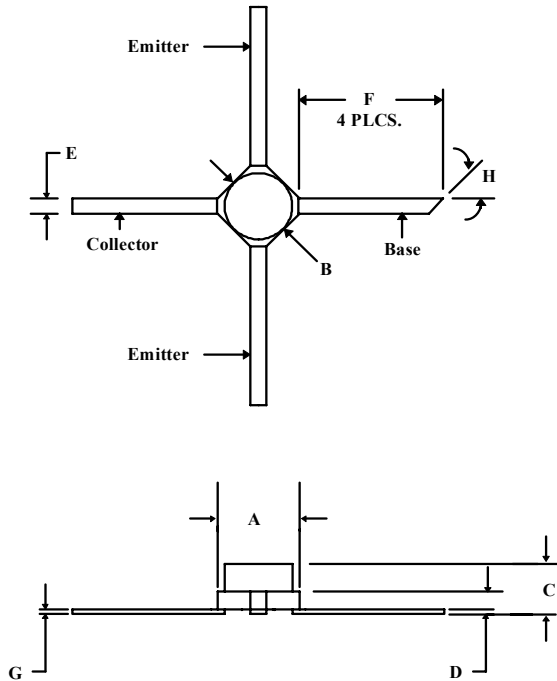

MP4T632535

DIM.	INCHES		MILLIMETERS	
	MIN.	MAX.	MIN.	MAX.
A	0.092	0.108	2.34	2.74
B	0.079	0.087	2.01	2.21
C	—	0.070	—	1.78
D	0.019	0.025	0.48	0.64
E	0.018	0.022	0.046	0.56
F	0.150	—	3.81	—
G	0.003	0.006	0.08	0.15
H	45°		45°	

SOT-143 - MP4T632539

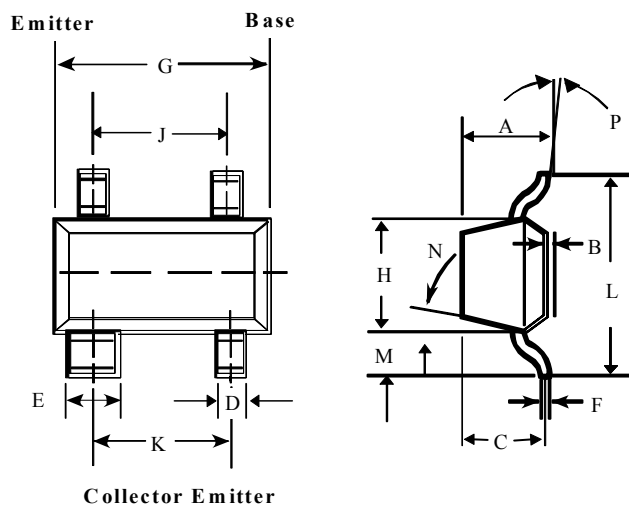

MP4T632539

DIM.	INCHES		MILLIMETERS	
	MIN.	MAX.	MIN.	MAX.
A	—	0.044	—	1.10
B	—	0.044	—	1.10
C	—	0.040	—	1.00
D	0.030	0.035	0.75	0.90
E	0.013	0.020	0.35	0.50
F	0.003	0.006	0.08	0.15
G	0.110	0.119	2.80	3.00
H	0.047	0.056	1.20	1.40
J	0.075 typical		1.90 typical	
K	0.075 typical		1.90 typical	
L	—	0.103	—	2.6
M	—	0.024	—	0.6

DIM.	GRADIENT
N	10° max. ¹
P	2° . . . 30°

NOTE:
1. Applicable on all sides

Specification Subject to Change Without Notice

M-Pulse Microwave

7
576 Charcot Avenue, San Jose, California 95131

Tel (408) 432-1480

Fax (408) 432-3440

Specification Subject to Change Without Notice

M-Pulse Microwave

8

576 Charcot Avenue, San Jose, California 95131

Tel (408) 432-1480

Fax (408) 432-3440